

Handrail system

- Handrail profiles
- End cap
- Accessoires

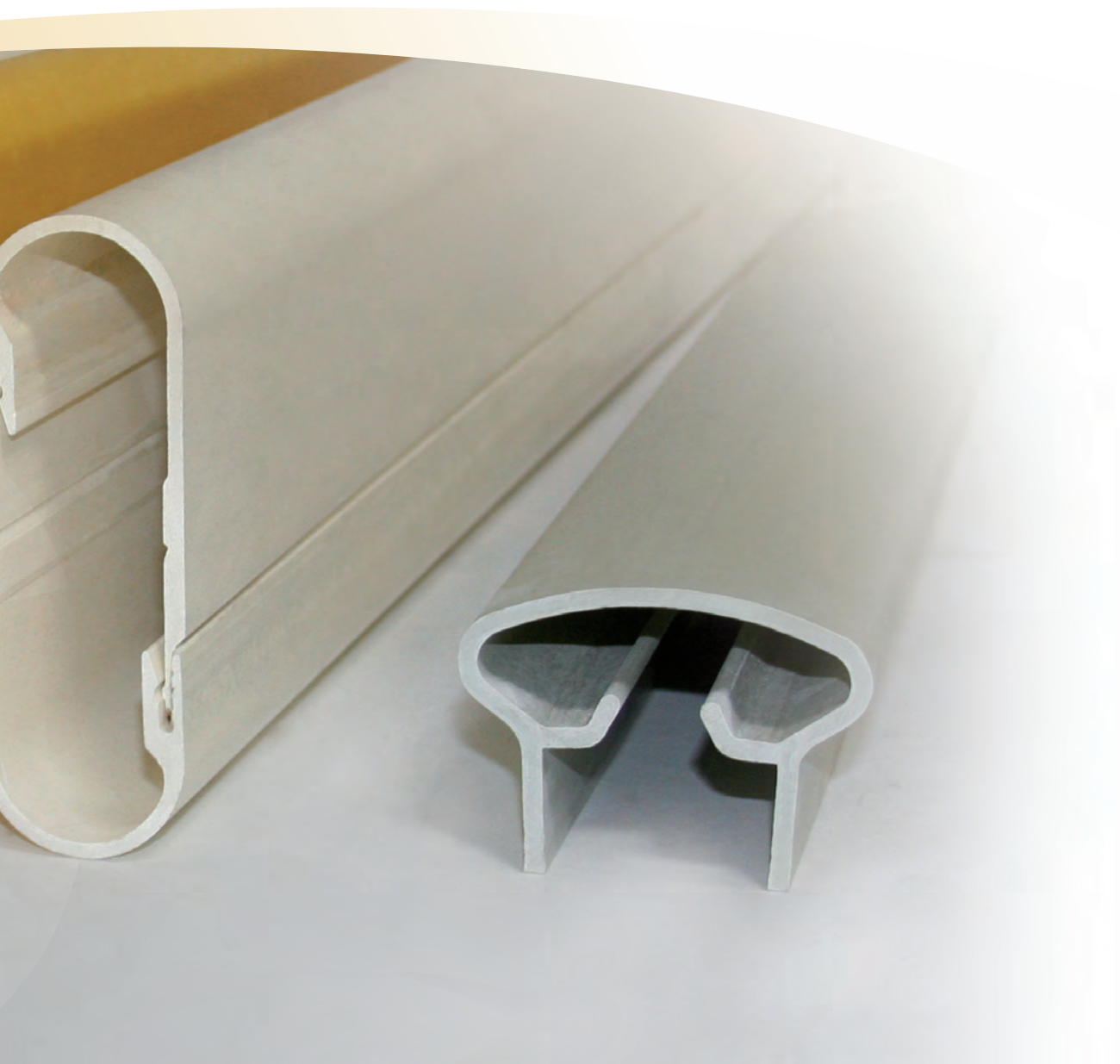

EBO Systems GRP handrails are ideal in tunnels and industrial facilities since a double function: support cables and help users find the exits in case of fire hazard.

These handrails can also be used as a security system in all hallways, corridors and stairwells.

We offer handrails incorporating closed or not passages, with cables or not, with optional lighting of safety equipment.

System overview of handrails

SYSTEM	GRP-Handrail	PR-MC 10	123
	GRP-Handrail	PR-MC 22	124
ACCESSORIES	GRP-Handrail coupler	PR-MC 10 GH	123
	GRP-Wall mounting angle plate	PR-MC 10 GM	123
	GRP-End cap	PR-MC 10 KE	123
	Polyamid bolts	PR-M860/PA6	123
	GRP-Riveted end cap	PR-MC 22 KE	124
	GRP-Clipsable end cap	PR-MC 22 KE/C	124
	GRP-Half end cap	PR-MC 22 KE/P	124
	GRP-Clipsable half end cap	PR-MC 22 KE/CP	125
	Supporting clamp E30	PR-MC 22 HBV	125
	GRP-Lighting support	PR-MC 22 BA	123
	GRP-Handrail	PR-MC 30	126
	GRP-Handrail coupler	PR-MC 30 IH	126
	GRP-Riveted end cap	PR-MC 30 KE	126
	Supporting clamp E30	PR-MC 30 HBV	126

Handrail

pultruded, with integrated cable tray

Item ref.	RAL colour	EAN code	Weight 100 units m	Min. pack.
K23 PR-MC 10	7032	965489	135	1 m

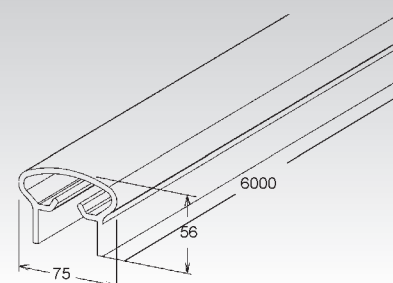

Splice plate

pultruded

Item ref.	RAL colour	Height mm	Width B mm	EAN code	Weight 100 units pc	Min. pack.
K23 PR-MC 10 GH	7032	20	150	968367	9	1 p.

Used for: Handrail PR-MC 10

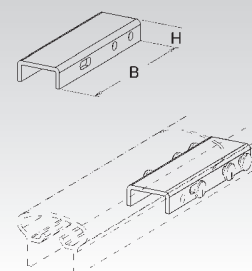

Wall-mounted angle plate

pressed

Item ref.	RAL colour	Height mm	Width B mm	EAN code	Weight 100 units pc	Min. pack.
K23 PR-MC 10 GM	7032	90	95	968374	15,6	1 p.

for the lateral handrail fixing on site

Used for: Handrail PR-MC 10

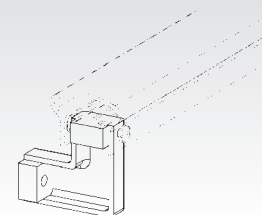
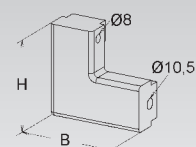

Handrail end cap

pressed

Item ref.	RAL colour	EAN code	Weight 100 units pc	Min. pack.
K23 PR-MC 10 KE	7032	968381	10	1 p.

for covering the profile ends

Used for: Handrail PR-MC 10

The end cap must be riveted on both sides

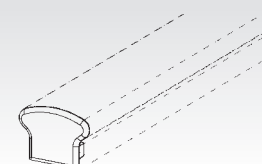

Polyamid bolt

Item ref.	EAN code	Weight 100 units pc	Min. pack.
K01 PR M860/PA6	968398	135	1 p.

for fixing the handrail on the wall-mounted angle plate

Used for: Handrail PR-MC 10

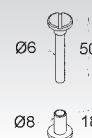

HANDRAIL SYSTEM MC

Handrail

pultruded, 2 pieces, with integrated cable tray

Item ref.	RAL colour	EAN code	Weight 100 units m	Min. pack.
K23 PR-MC 22	7032	965496	900	3 m

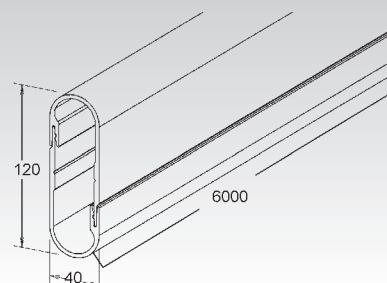

Riveted handrail end cap

pressed

Item ref.	RAL colour	EAN code	Weight 100 units pc	Min. pack.
K23 PR-MC 22 KE	7032	966172	3,4	1 p.

for covering the handrail ends

For more safety, we recommend to add reflectors.

Used for: Handrail PR-MC 22

The reflectors will be added on request (to be ordered separately)

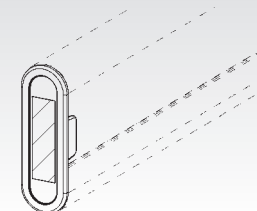

Clipsable handrail end cap

pressed

Item ref.	RAL colour	EAN code	Weight 100 units pc	Min. pack.
K23 PR-MC 22 KE/C	7032	966196	3,9	1 p.

for covering the handrail ends

For more safety, we recommend to add reflectors.

Used for: Handrail PR-MC 22

The reflectors will be added on request (to be ordered separately)

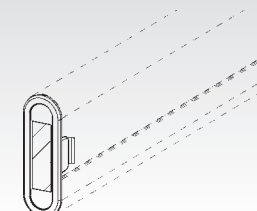
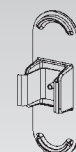

The half end cap must be riveted

pressed

Item ref.	RAL colour	EAN code	Weight 100 units pc	Min. pack.
K23 PR-MC 22 KE/P	7032	966189	1,6	1 p.

for covering the handrail ends

For more safety, we recommend to add reflectors.

Used for: Handrail PR-MC 22

The reflectors will be added on request (to be ordered separately)

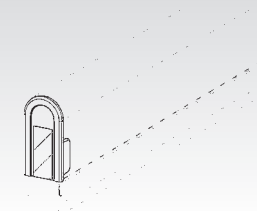

The half end cap must be clipped

pressed

Item ref.	RAL colour	EAN code	Weight 100 units pc	Min. pack.
K23 PR-MC 22 KE/CP	7032	966202	1,8	1 p.

for covering the handrail ends

For more safety, we recommend to add reflectors.

Used for: Handrail PR-MC 22

The reflectors will be added on request (to be ordered separately)

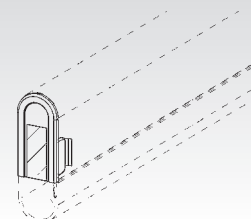

Hold down clamp for cables E30

stainless steel

Item ref.	EAN code	Weight 100 units pc	Min. pack.
E3 PR-MC 22 HBV	966219	9	1 p.

Used for: Handrail PR-MC 22

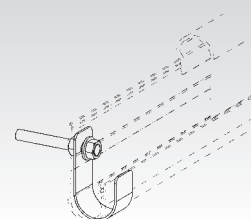

Lighting support

pressed

Item ref.	RAL colour	EAN code	Weight 100 units pc	Min. pack.
K23 PR-MC 22 BA	7032	966158	75	1 p.

for the display of emergency exits on the handrail profile

Used for: Handrail PR-MC 22

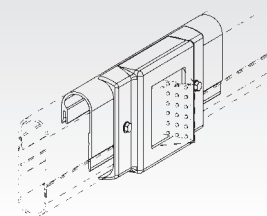
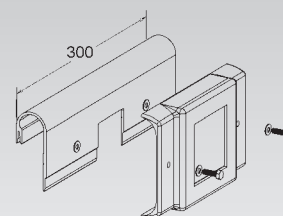

HANDRAIL SYSTEM MC

Handrail

pultruded, 2 pieces, with integrated cable tray

Item ref.	RAL colour	length unit	EAN code	Weight 100 units m	Min. pack.
K23 PR-MC 30	7032	6 m	965502	450	3 m

to separate the low voltage and high voltage cables

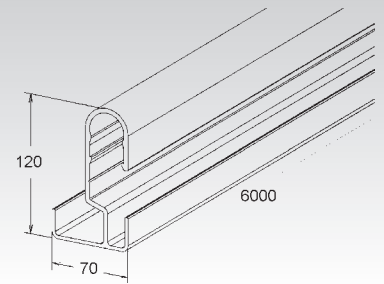

Clipsable splice plate

stainless steel

Item ref.	EAN code	Weight 100 units pc	Min. pack.
E4 PR-MC 30 IH	966226	9	1 p.

Used for: Handrail PR-MC 30

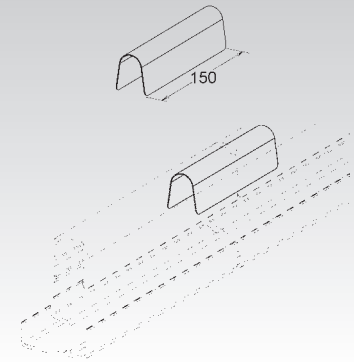

End cap, (clippable)

pressed, with reflector on request

Item ref.	RAL colour	EAN code	Weight 100 units pc	Min. pack.
K23 PR-MC 30 KE	7032	966233	4,1	1 p.

for covering the handrail ends

For more safety, we recommend to add reflectors.

Used for: Handrail PR-MC 30

The half end cap must be riveted on both sides

The reflectors will be added on request (to be ordered separately)

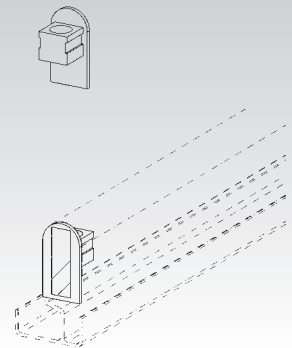

Wall-mounted angle plate E30

stainless steel

Item ref.	EAN code	Weight 100 units	Min. pack.
E3 PR-MC 30 HBV	968404	135	1 m

Used for: Handrail PR-MC 30

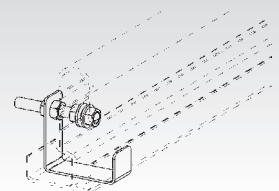
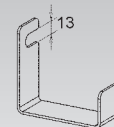

NOTES

